

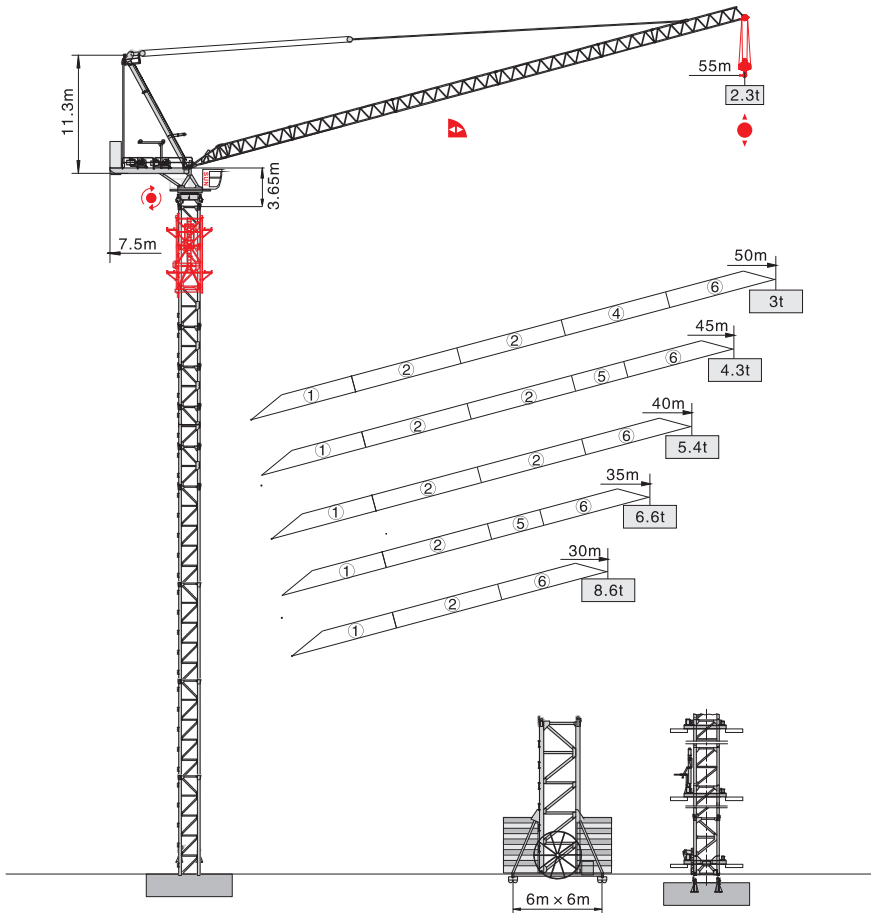

QTD5523-12t



塔身截面 Mast 2m × 2m

固定式 Stationary

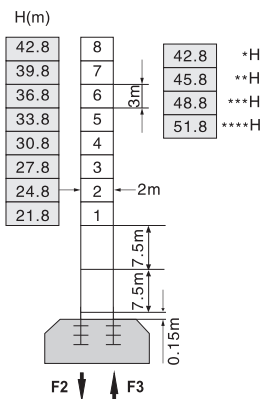

F2	●165t	■300t
F3	●115t	■257t
	75t	

行走式 Traveling

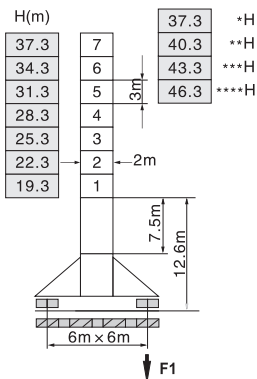

F1	●109t	■143t
	84t	

内爬式 Inner climbing

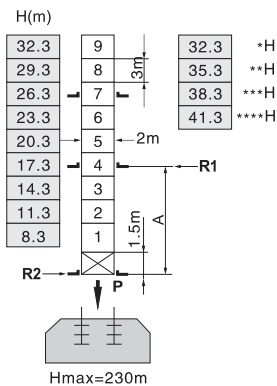

A	12m	16m
R1	31t	23t
R2	27t	20t
P	90t	90t
	77t	

H 臂根铰点下高度 Height under jib hinge shaft 臂架 Jib *55m **50m ***45-40m ****35-30m

● 工作状态 In service

F=固定反力或轮压 Reactions

■ 非工作状态 Out of service

自重 Total weight without load and counter weight

附着 Anchorage 2m × 2m

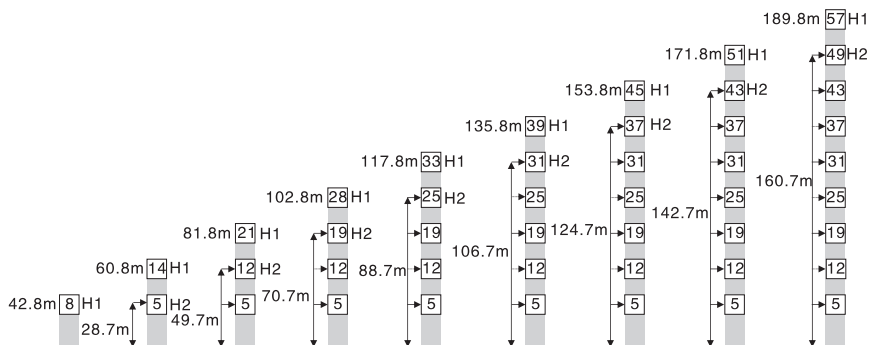

H1—臂根铰点下高度 Height under jib hinge shaft

H2—塔机附着位置距地面的高度 Height of anchorage frame to the ground

① > 189.8m 请向我司咨询 Consult us

载荷特性表 Load Diagrams

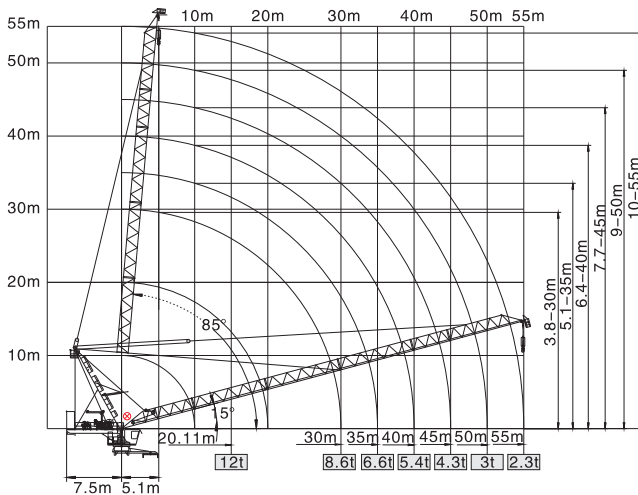

起重臂 Jib (m)	倍率 Fall	起重幅度 Range (m)	5.1-20.11	25	30	35	40	45	50	55
55	IV	起重量	12	8.92	6.8	5.29	4.16	3.28	2.58	2.1
	II	Load (t)	6			5.49	4.36	3.48	2.78	2.3
50	IV	起重幅度 Range (m)	4.7-20.33	25	30	35	40	45	50	
	II	起重量	12	9.11	7	5.5	4.38	3.5	2.8	
45	IV	起重幅度 Range (m)	4.3-21.76	25	30	35	40	45		
	II	起重量	12	10.02	7.8	6.21	5.03	4.1		
40	IV	起重幅度 Range (m)	3.8-21.92	25	30	35	40			
	II	起重量	12	10.14	7.95	6.38	5.2			
35	IV	起重幅度 Range (m)	3.3-22.25	25	30	35				
	II	起重量	12	10.37	8.17	6.6				
30	IV	起重幅度 Range (m)	2.9-23	25	30					
	II	起重量	12	10.38	8.6					

载荷特性 Load Diagrams









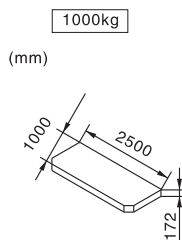
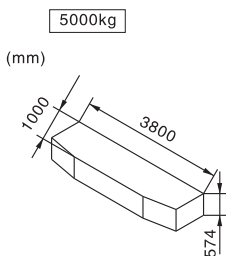
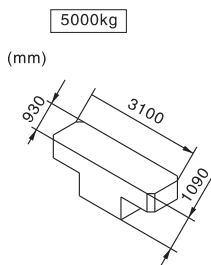

⊗ 臂根铰点 Jib hinge shaft

配重配置表 Counter Weight

		5000kg	5000kg	1000kg	 kg
55m	7.5m	1	3	3	23000
50m	7.5m	1	3	1	21000
45m	7.5m	1	3	1	21000
40m	7.5m	1	3	-	20000
35m	7.5m	1	3	-	20000
30m	7.5m	1	3	-	20000



机构特性 Mechanisms

机构名称 Name	机构型号 Model						功率 Power
起升 Hoisting 	75LVF30	m/min	t	m/min	t	600m 变频控制 Inverter Control	55Kw
		0-45	6	0-22.5	12		
		0-90	3	0-45	6		
拉臂 Luffing 	50DVF40	min	≤3.0		变频控制 Inverter Control	37Kw	
回转 Slewing 	RCV120	r/min	0-0.7		变频控制 Inverter Control	2×6Kw	
	RVF120	r/min	0-0.7			2×6Kw	
行走 Traveling 	18TVF	m/min	0-25		变频控制 Inverter Control	4×3.4Kw	
电网/Power Supply				380V/50Hz 440V/60Hz (±5%)			
供电容量/Necessary Power				130KVA/147KVA (traveling)			

※ 本技术参数不受法律约束，技术信息请详见相应技术说明书。

Specifications and data is not legally binding.

For any technical information, please refer to the corresponding instructions.